

























## MT174

### Polyphase meter

**MT174** is a polyphase multifunction meter used for measurement of active, active and reactive or active, reactive and apparent energy and demand in three-phase four- or three-wire networks. It can be connected directly or via CT. The meter can also be used in single phase two-wire networks. The meters comply with both European (EN 50470-1 and EN 50470-3) and international (IEC 62052-11 and IEC 62053-21) standards, and are designed and manufactured in compliance with the ISO 9001 standard. The kvarh-meter complies with the IEC 62052-23 standard.



-   Active, active and reactive or active, reactive and apparent energy
-  Maximum demand and instantaneous power
-  One or two energy flow directions or always positive registration
-  Multirate registration
-  Internal real time clock
-  Load profile registration (8-channel)
-    Measurement of phase voltages, currents, power factors and frequency
-  Interface RS485
-    Multi-phasing
-  Pulse output(s)  
Option: Tariff output(s) instead of pulse output(s)

-  Fast and easy installation procedure, indications of correct connection
-  Compact meter case with IP54 protection
-  Multi-phasing connection (all-in-one: poly- and single-phase meter)
-  Universal current terminal for all types of conductors
-  Indications of meter operation status
-  Antifraud features
-  Very high EMC immunity level
-  Optical port and optionally RS485 interface
-  Internal real time clock
-  Powerful load profile recorder with up to 8 channels

## FUNCTIONAL AND TECHNICAL DATA

The **MT174** polyphase meter is intended for residential and small commercial customers. It is used for revenue measuring of active, active and reactive or active, reactive and apparent energy and demand in three-phase four- or three-wire networks.

**Measuring and registration:**

- One energy flow direction (import)
- Two energy flow directions
- Always positive (absolute)
- Four-quadrant for reactive energy (option)

**Accuracy/calibration:** There is no need for meter recalibration due to long-term metering stability.

### Indications:

- LED 1** (red): kWh impulses
- LED 2** (red): kvarh impulses (option)
- LED 3** (red): kVAh impulses (option)
- Blinking:** the load current is higher than the starting current
- Lit:** voltage applied to the meter, the load current is smaller than the starting current
- Turned-off:** no voltage applied to the meter

**Communication:** Optical port (IEC 62056 – 21) for local meter programming and data downloading, RS485 serial interface.

**Multi-phasing metering operation:** The meter can be connected as a single, two- or three-phase meter.

**Multirate registration:** Internal time-switch or external tariff changeover. Programmable number of rates (1 ... 4 rates, 10 day types, 10 seasons, 46 holidays).

### 7-segment LCD:

- In compliance with VDEW recommendation, 8 digits for data + 5 digits for EDIS code (DIN 43863-3) + 11 signal flags; indicators: energy flow direction and presence of phase voltages
- Automatic scroll mode
- Manual scroll mode (with a pushbutton)
- Programmable data set and sequence
- *Option: data display on LCD in no-voltage state*

### Real time clock:

- 32 kHz quartz crystal
- Time keeping accuracy better than prescribed by IEC 62054-21 standard
- RTC back-up power supply: Li-battery
- The real time clock enables: tariff changeover, seasons changeover, transition to day light saving period and vice-versa, demand and load profile periods

### Current terminals:

- Directly connected meters: A universal clamping type for all types of wires (diameter  $\phi = 9.5$  mm or  $\phi = 8.5$  mm)
- Transformer operated meters: solid brass with bore diameter  $\phi 5.5$  mm

**Enclosure:** Self-extinguishing UV stabilized polycarbonate

**Protection against water and dust:** IP 54

## OVERALL AND METER FIXING DIMENSIONS

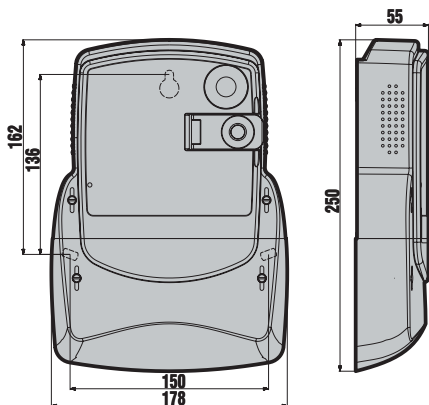

Accuracy class (kWh)	..... A or B (by EN 50470-3) 2 or 1 (by IEC 62053-21)
(kvarh)	..... 3 or 2 (by IEC 62053-23)
(kVAh)	..... 3 or 2
Reference / Basic current I <sub>b</sub>	..... 5, 10, 15, 20 A (directly connected meters) 1 A (CT operated meters)
Max. current I <sub>max</sub>	..... 60, 80, 85, 100, 120 A (directly connected meters) 6 A (CT operated meters)
Min. current	..... 0.05 I <sub>b</sub>
Starting current	..... 0.004 I <sub>b</sub> (directly connected meters) 0.002 I <sub>b</sub> (CT operated meters)
Reference voltage U <sub>r</sub>	..... 3 x 230/400 V, 3 x 400 V, 3 x 230 V, 230 V
Voltage range	..... 0.8 U <sub>r</sub> ... 1.15 U <sub>r</sub>
Reference frequency	..... 50 Hz or 60 Hz
Operating temper. range	..... -40°C ... +60°C (LCD: -25°C ... +60°C)
Extended temper. range	..... -40°C ... +70°C
Storage temperature	..... -40°C ... +85°C
Optical port	..... IEC 62056-21
RTC (IEC 62054-21)	..... ≤±3 min/year
RTC operation reserve	..... 5 years (Li-battery)
Pulse output(s) IEC 62053-31, class A (S0)	..... t <sub>i</sub> = 40 ms (10, 20, 30, ... 160 ms)
Optomos relay	..... t <sub>i</sub> = 80 ms, ... 160 ms
Tariff output(s)	..... Optionally instead of impulse output
Current circuit burden	..... <0.5 VA
Voltage circuit burden	..... <1 W / 10 VA
Dielectric strength	..... 4 kV, 50 Hz, 1 min
Impulse voltage main circuits:	..... 12 kV (aux. circuits: 6 kV), 1.2/50 μs
CT operated:	..... 6 kV, 1.2/50 μs
Short-circuit current	..... 30 I <sub>max</sub>
Fast transients (burst)	..... 6 kV (IEC 61000-4-4)
Dimensions	..... 250 x 178 x 55 mm
Mass	..... 1 kg

## TYPE DESIGNATION FOR ORDERING

### MT174-D1A41R51S5-V22G22-M3K03Z

- M** – Electronic meter
- T** – Three-phase three-element meter
- 174** – Multi-tariff meter with LCD, RTC and maximum demand indicator
- D1** – Terminal block up to 85 A for direct connection
- D2** – Terminal block up to 120 A for direct connection
- T1** – Terminal block up to 6 A for indirect connection
- A5** – Active energy measurement, accuracy class A (by EN 50470-3) 2 (by IEC 62053-21)
- A4** – Active energy measurement, accuracy class B (by EN 50470-3) 1 (by IEC 62053-21)
- 1** – Measurement in one energy flow direction
- 2** – Measurement in two energy flow directions
- 4** – Measurement in two energy flow directions, absolute registration
- R6** – Reactive energy measurement, accuracy class 3 (option)
- R5** – Reactive energy measurement, accuracy class 2 (option)
- 1** – Measurement in one energy flow direction
- 2** – Measurement in two energy flow directions
- 5** – Measurement in four quadrants
- 6** – Measurement in four quadrants and two energy flow directions
- S6** – Apparent energy measurement, accuracy class 3 (option)
- S5** – Apparent energy measurement, accuracy class 2 (option)
- V12** – 1 tariff input
- V22** – 2 tariff inputs
- G12** – 1 pulse output, class A by IEC 62053-31(S0 by DIN 43864)
- G22** – 2 pulse outputs, class A by IEC 62053-31(S0 by DIN 43864)
- L11** – 1 optomos relay pulse output, make contact (option: tariff output)
- L21** – 2 optomos relay pulse outputs, make contact (option: tariff outputs)
- M3** – RTC with Li-battery as back-up supply
- K** – Communication channel
- 0** – Optical port in compliance with IEC 62056-21
- 3** – RS485 (option)
- Z** – Load profile recorder (option)

Owing to periodical improvements of our products the supplied products can differ in some details from the data stated in the prospectus material.

Iskraemeco, Energy Measurement and Management  
 4000 Kranj, Savska loka 4, Slovenia  
 Telephone: (+386 4) 206 40 00, Telefax: (+386 4) 206 43 76,  
<http://www.iskraemeco.si>, e-mail: [info@iskraemeco.si](mailto:info@iskraemeco.si)  
 Published by Iskraemeco. Data subject to alteration without notice.